

Sanitary partition wall type EF-3 JUMP

Sandwich elements with solid grade laminate surface

schäfer[®]
Trennwandsysteme



Stylish and elegant partitioning.



BEFORE WE
EXPECT TRUST FROM
OUR CUSTOMERS,
WE PROVIDE EVIDENCE
that's us!

ENVIRONMENT & SUSTAINABILITY *that's us!*

Sustainable management and careful use of resources are a matter of course for us and part of our corporate philosophy. This basic idea is consistently integrated and lived in our work processes. We are proud to be the first certified manufacturer of partition systems and lockers in Germany to operate according to the FSC™ and PEFC guidelines.

PEFC - registered

We pay attention to a sustainable supply chain in which our products are procured under ecological, economic and socially just aspects.

FSC™ - certified

As the first certified manufacturer in the area of partition systems and lockers in Germany, we make an active contribution to the protection of our earth with this future-oriented procurement method. We supply almost our entire range from sustainable wood in accordance with the specifications of the FSC™.



On request
the products are
available with
FSC™ certification

To certificate >

CLEAN & HEALTHY INDOOR CLIMATE *that's us!*

Products that have received Greenguard Gold certification have been proven to provide a better and healthier indoor climate by helping to reduce chemical pollution in the air. The Greenguard Gold certification focuses in particular on health-related test criteria and extremely low chemical emission values, so that products tested according to this standard can also be used without problems in sensitive environments, such as schools or healthcare facilities.



TÜV NORD GS TESTED SAFETY *that's us!*

Tested and certified by TÜV NORD these products meet the requirements of the Product Safety Act ProdSG § 21
Registration No. 44 329 14148801



MADE IN GERMANY *that's us!*

Our products are manufactured for you at the company site in Horhausen, Rhineland-Palatinate. This is the only way we can guarantee the high quality standards we set for our products.



PREQUALIFIED *that's us!*

We are registered in the list of prequalified construction companies with the number 010.049740, proving that we are qualified for the products and services we offer.



For listing >

INNOVATIVE & DESIGN-ORIENTED *that's us!*

With our design-oriented and innovative products, we convince not only our customers, but also national and international committees.



reddot winner 2021



Floating walls. Floating optics.

The EF-3 JUMP cubicle system impresses with its floating appearance. This gives the sanitary room a special lightness. It seems as if the system is floating. An optical highlight combined with an efficient side effect. Due to its construction, the WC partition wall is supported on recessed feet. The resulting floor clearance makes maintenance much easier. Cleaning can be carried out more quickly and therefore more efficiently. The recessed supports and headrail are the heart of this system in conjunction with the wall connections made as shadow gaps.



Interesting facts about EF-3 JUMP

WC partition walls made of 36 mm thick sandwich elements with HPL surface

- Recessed supports and headrail give a floating look
- No support feet visible in the front
- Floor clearance ensures a quick and effective cleaning
- Flush front
- Wall connections are done as shadow gaps
- Hardware made of high-quality anodised aluminium
- Fully waterproof construction
- Suitable for wet and dry areas
- Large variety of decors and colours
- Customised motif prints are possible
- System will be produced acc. to the building site dimension



Privacy screens

- Wall-mounted privacy screens
- Made of 13 mm solid grade laminate
- Revolving edge is always black
- Installed with durable aluminium holders
- Waterproof
- Wall-mounted structures without bottom support feet are particularly hygienic, since floor cleaning can then be faster and more efficient
- Wide range of colors available
- Motif prints are optionally available
- Privacy screens will be produced acc. to the building site dimension



(1)

Sanitary partitions

- Construction with recessed supports and recessed headrail
- In constructions with large cubicle widths, the front parts are stabilised by a support
- Good visibility and easy visitor guidance through free/ occupied LED display
- An energy-saving LED strip quickly and clearly indicates the occupancy status
- Vertical LED strip is flush fitted into the front parts

(3)

Privacy screens

- Wall-hanging privacy screens type EF-3
- Easy to clean and maintain



(2)



(3)



(1)

Handrail for toilet partition type EF-3 JUMP

- Matt, natural anodised
- Very easy to clean
- Integrated Free/engaged indicator (4)
- Emergency opening located below – allows the locked door to be opened from the outside (5)
- Optional available with LED
- Optional energy-saving LED strip shows the locking status clearly visible
- Very good grip, because of the body-friendly shape

Possible Variation:

(1)

- Handrail adapted to the door length, always until the top edge of the door
- Optional available: in combination with a LED strip

(2)

- Handrail 55 x 1.150 mm
- Optional available: in combination with a LED strip

(3)

- Handrail 55 x 500 mm
- Optional available: in combination with a LED strip



(2)



(3)

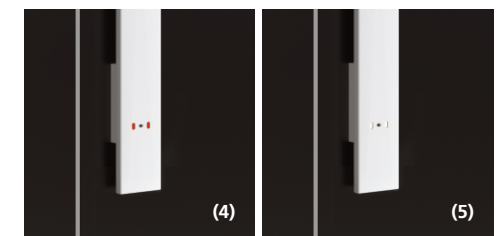

(4)

(5)

Features type EF-3 JUMP

Headrail:



- Headrail recessed by 150 mm behind the front wall
- Aluminium brackets and angles ensure a stable construction

Supports:



- Dividing wall with recessed aluminium support
- Support holder made of anodised aluminium
- Stabilisation of the front elements by means of T-connectors under the dividing wall and front element, tightly screwed

Hinges:



- Anodised aluminium rising hinge with high-performance polymer
- Treads guarantee absolute freedom from maintenance and a silence, self-closing of the door
- Door hinges are generally used for door openings over 110°



- Optional available: hinges located in the door rebate which ensure a complete flush front wall
- Optional available: internal tube door closer for a self-closing function of the door

Variation of accessories type EF-3 JUMP

Hardware:



Aluminium
door handle
Schäfer AL7050



Stainless steel
door handle
Schäfer ES6050



Nylon
one hand door knob
Schäfer N8015



Stainless steel
one hand door knob
Schäfer ES6011



Aluminium
one hand door knob
INSAFE
Schäfer ES6011



Aluminium
push handle SLIDESAFE
Schäfer AL7011

[To the handrail configuration online tool >](#)

[To the push handle SLIDESAFE >](#)

[To the sanitary accessories >](#)

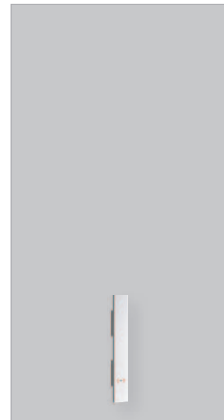

Aluminium handrail
55 x 500 mm
Schäfer ALGS1

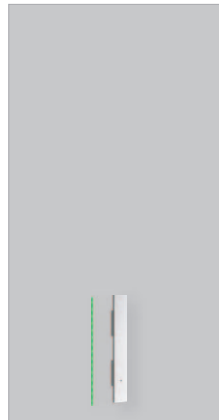

Aluminium handrail
with LED strip
55 x 500 mm
Schäfer ALGS1 LED

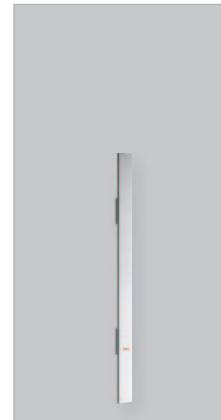

Aluminium handrail
55 x 1.150 mm
Schäfer ALGS2

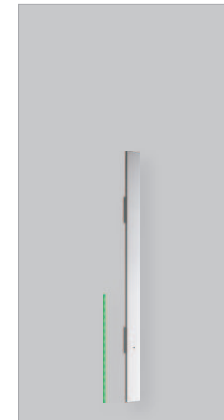

Aluminium handrail
with LED strip
55 x 1.150 mm
Schäfer ALGS2 LED

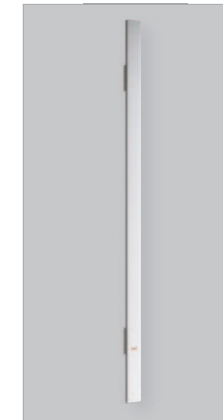

Aluminium handrail,
adapted to the door
length, always until the
top edge of the door
Schäfer ALGSV



Aluminium handrail with
LED strip, adapted to the
door length, always until
the top edge of the door
Schäfer ALGSV LED

Buffer and hooks:



Aluminium buffer
Schäfer AL7015



Stainless steel buffer
Schäfer ES6015



Nylon buffer
Schäfer N8015



Aluminium hook
Schäfer AL7011



Stainless steel hook
Schäfer ES6011



Nylon hook
Schäfer N8010

Colours type EF-3 JUMP

Panels:



21001
Weiß

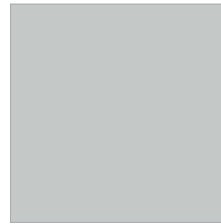

11002
Hellgrau



14001
Aluminiumgrau
Metallic



21004
Anthrazit

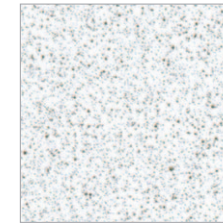

13001
Pepper Weiß



12006
Limonengrün



12003
Atlantik



12005
Rot



12001
Mango

Profiles:

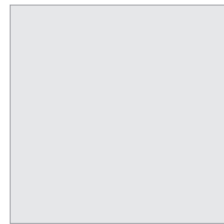

E6/EV1
Eloxiert

Special colours for panels, wall-connection profiles in all RAL colours and special accessories are available upon request. Ask us!

There may be a difference between printed colours and real colours.

Technical design of cubicle system type EF-3 JUMP

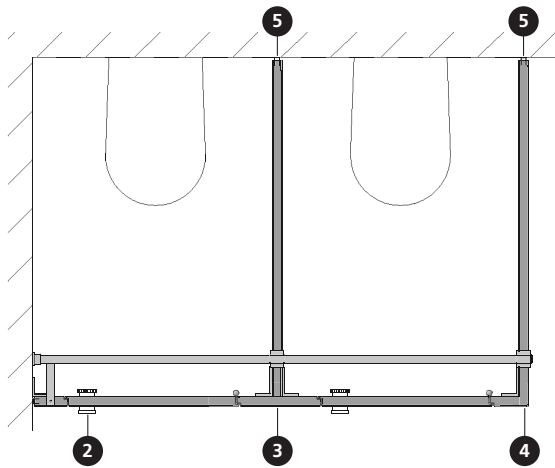

2 Sectional view: front wall with one hand door knob
Rising hinges made of aluminium

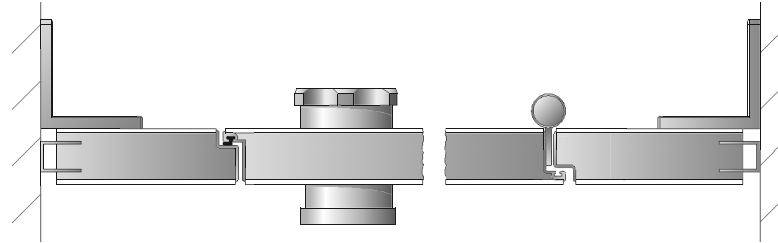

3 Front to partition wall connection

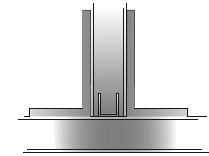

Front height section

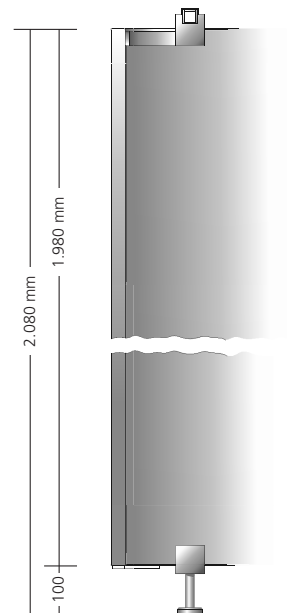

4 Corner connection

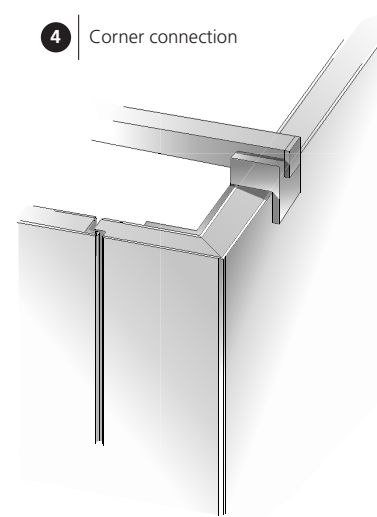

5 Wall connection

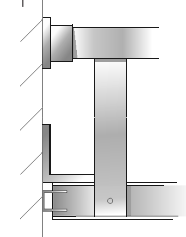

5 Wall connection

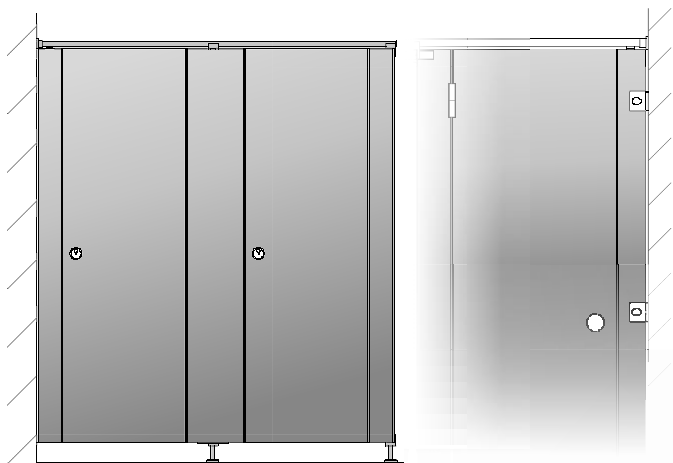
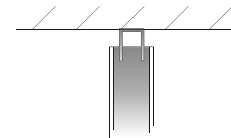

We reserve the right to make technical alterations.



reddot winner 2021

