

WANDWASTAFEL URBAN V

130952

WWW.LOGGERE.COM

Omschrijving:

Wastafel voor wandmontage met 2 geïntegreerde handdoek ophanging mogelijkheden.

Materiaal:

- RVS, AISI 304, dikte 1,2/ 1,5/ 3 mm, afwerking geborsteld.

Afmetingen:

- B 600 x D 395 x H 150 mm.
- Kraangat: Ø 35 mm.

Aansluiting:

- Afvoer 1 ¼" Ø 32 mm.

Normen:

- EN 14688:2015 + A1:2018

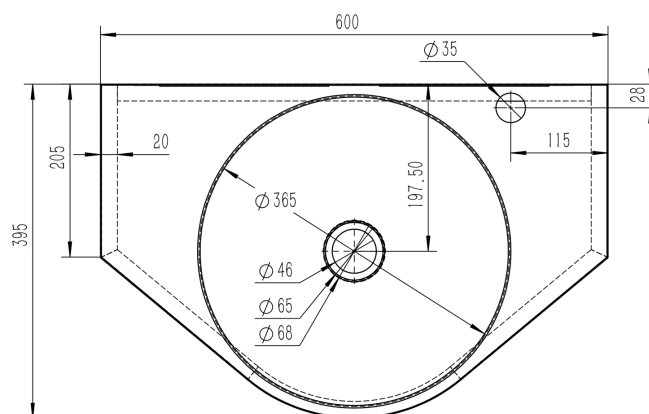
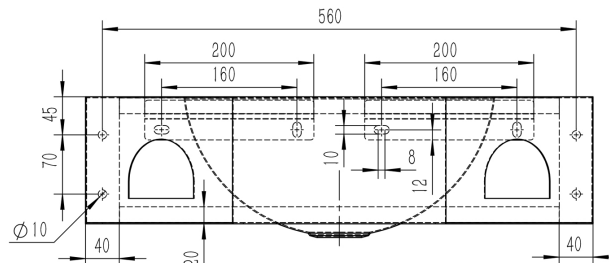
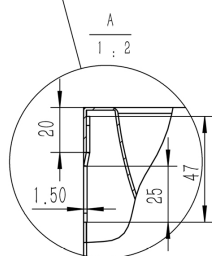
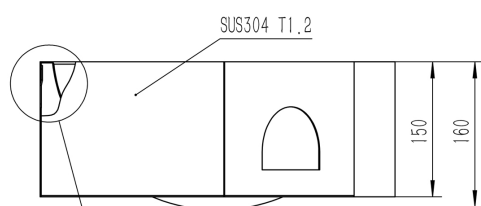
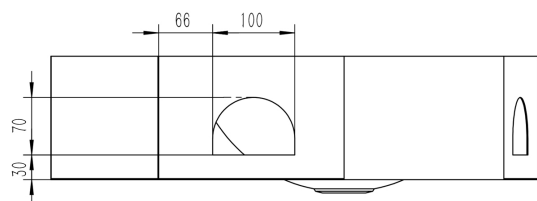

Bijzondere voordelen:



Voldoet aan CE norm

Verdere Loggere productaanbevelingen

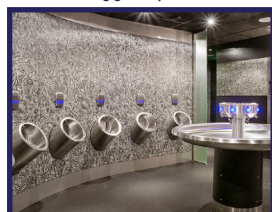

Sanitair

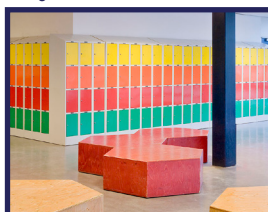

Lockers en kastsystemen



Sanitaire wanden



Garderobesystemen



Kantoorunits