

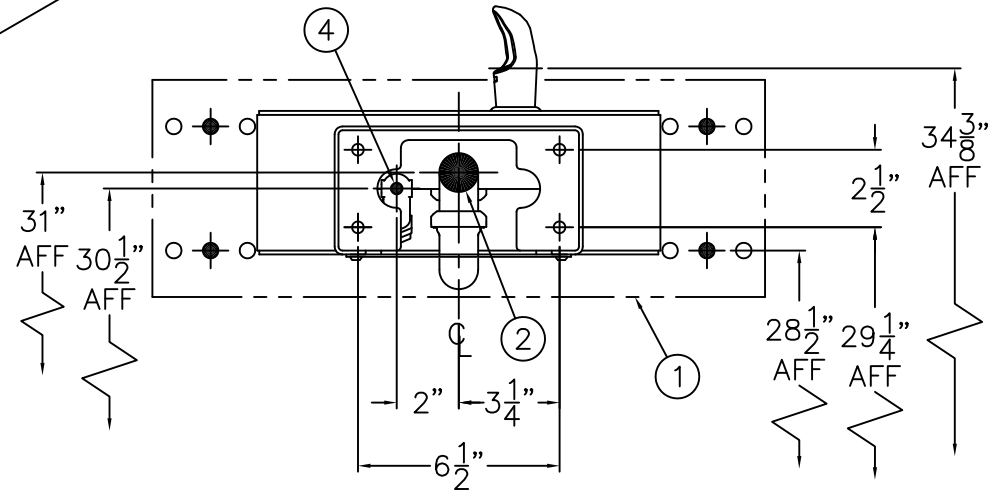

**DETAIL A
FLOW ADJUSTMENT**



BACK ROUGH-IN VIEW

INSTALLATION INSTRUCTIONS:

- A- REFER TO DRAWING # 9938-375-001 TO INSTALL STANDARD SUPPLIED WALL MOUNTING PLATE ①.
- B- ROUGH-IN WASTE OUTLET ② AT DIMENSION SHOWN FOR 1-1/4" OUTER DIAMETER PLAIN END P-TRAP ③.
- C- ROUGH-IN WATER SUPPLY ④ AT DIMENSION SHOWN FOR THE 1/4" NOMINAL (3/8" O.D.) x 4" LONG COPPER TUBE CONNECTED TO THE IN-LINE STRAINER ⑤ PROVIDED. STOP RECOMMENDED ON SUPPLY IS TO BE SUPPLIED BY OTHERS.
- D- CAREFULLY REMOVE FIXTURE ⑥ AND COMPONENTS FROM THE PACKAGING PREVENTING SCRATCHING AND DAMAGE.
- E- REMOVE BOTTOM ACCESS PANEL ⑦. ASSEMBLE P-TRAP ③ TO UNIT. ENSURE PUSHBUTTON ⑧ AND THE BUBBLER ARE SECURE AND CHECK ALL THE TUBING CONNECTIONS TO MAKE SURE THEY DID NOT COME LOOSE IN SHIPMENT.
- F- SLIDE FIXTURE OVER STUDS FROM WALL MOUNTING PLATE ① AND SECURE WITH NUTS AND WASHERS ⑨.
- G- MAKE-UP 1-1/4" O.D. WASTE CONNECTION TO P-TRAP ③.
- H- FLUSH WATER SUPPLY ④ BY OTHERS OF ALL DEBRIS PRIOR TO CONNECTING TO FIXTURE.
- I- CONNECT WATER SUPPLY ④ BY OTHERS TO 1/4" NOMINAL COPPER TUBE INLET. STOP ON THE SUPPLY IS RECOMMENDED.
- J- TEST OPERATION OF BUBBLER BY DEPRESSING BUTTON ⑧. ADJUST THE FLOW RATE AS REQUIRED. SEE DETAIL A. CHECK ALL CONNECTIONS AND WASTE PIPING FOR LEAKS. CORRECT IF PRESENT.
- K- RE-INSTALL BOTTOM ACCESS PANEL ⑦.

 MURDOCK-SUPER SECUR P.O. Box 3527 Industry, CA 91744 15125 Proctor Ave Industry, CA 91746 Phone: (800) 591-9880 www.murdock-supersecur.com	TITLE ROUND OUTDOOR STEEL WALL MOUNTED DRINKING FOUNTAIN	
	MANUFACTURE DATE JANUARY 2006 TO PRESENT	DATE ISSUED 09/27/05 DATE REVISED 03/11/16



INSTALLATION INSTRUCTIONS

DRINKING FOUNTAIN

ROUGH-IN FOR 3/8" OD PUSH-IN SUPPLY INLET, STRAIGHT STOP RECOMMENDED. *1/4" NCT x 2" LONG TUBE STUB OUT PROVIDED.
ROUGH-IN FOR 1-1/4" OD P-TRAP WASTE OUTLET.

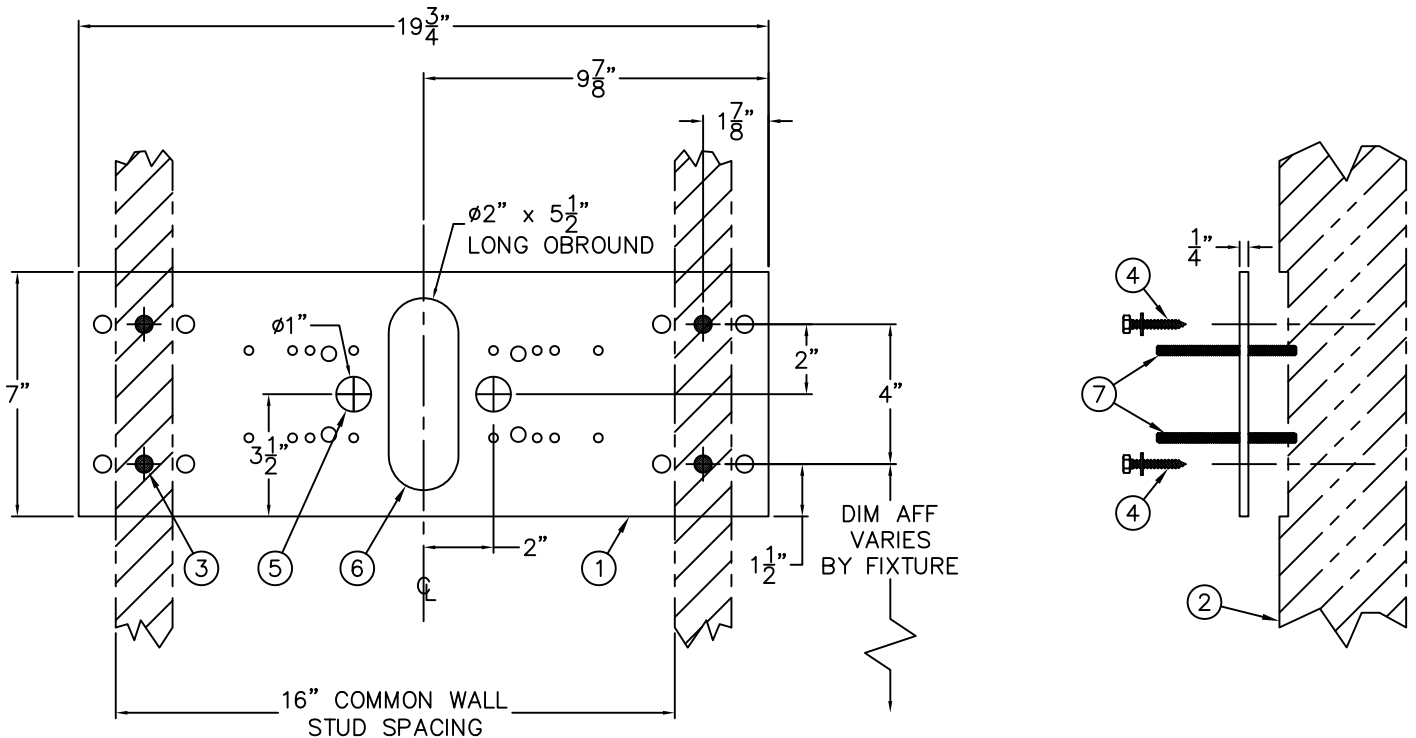

INSTALLATION INSTRUCTIONS:

- A-PLATE ① INTENDED TO BE RECESSED FLUSH WITH SUPPORT FRAMING ② PROVIDED BY INSTALLER. FRAME & BLOCK OUT SUPPORT USING DIMENSIONS SHOWN. FRAME SHOULD SUPPORT 300 LBS MINIMUM.
- B-MOUNTING PLATE ① IS 1/4" THICK AND INCLUDES 12, 1/2" DIAMETER PUNCHING FOR ANCHORING HARDWARE BY OTHERS.
- C-STRIKE A HORIZONTAL CHALK LINE TO LOCATE BOTTOM MOUNTING HOLES ③. REFERENCE DISCHARGE HEIGHT REQUIREMENTS FOR YOUR MODEL AND FACILITY TO DETERMINE CORRECT HEIGHT AT FINISHED FLOOR (AFF).

- D-AFTER POSITIONING PLATE CORRECTLY, FIX PLATE TO WALL USING APPROPRIATE, INSTALLER PROVIDED ANCHORING HARDWARE ④.
- E-MAKE UP APPROPRIATE SUPPLY ⑤ AND WASTE ⑥ ROUGHS THROUGH MOUNTING PLATE OPENINGS. A STRAIGHT SUPPLY STOP IS RECOMMENDED.
- F-REFER TO FIXTURE INSTALLATION SHEETS TO LOCATE 5/16" THREADED STUDS MOUNTING HARDWARE AND THREAD STUDS ⑦ THRU PLATE SO THAT A MINIMUM OF 1-1/4" OF THREAD PROJECTS BEYOND THE FINISHED WALL MATERIAL.
- G-PROTECT THREADED STUDS ⑦, SUPPLY ⑤ AND WASTE ⑥ ROUGHS WHILE FINISHING WALL.

<p>MURDOCK-SUPER SECUR P.O. Box 3527 Industry, CA 91744 15125 Proctor Ave Industry, CA 91746 Phone: (800) 591-9880 www.murdock-supersecur.com</p>	<p>TITLE -MP1 WALL MOUNTING PLATE</p>	
	<p>MANUFACTURE DATE JANUARY 2006 TO PRESENT</p>	<p>DATE ISSUED 09/28/05</p> <p>DATE REVISED 03/02/16</p>

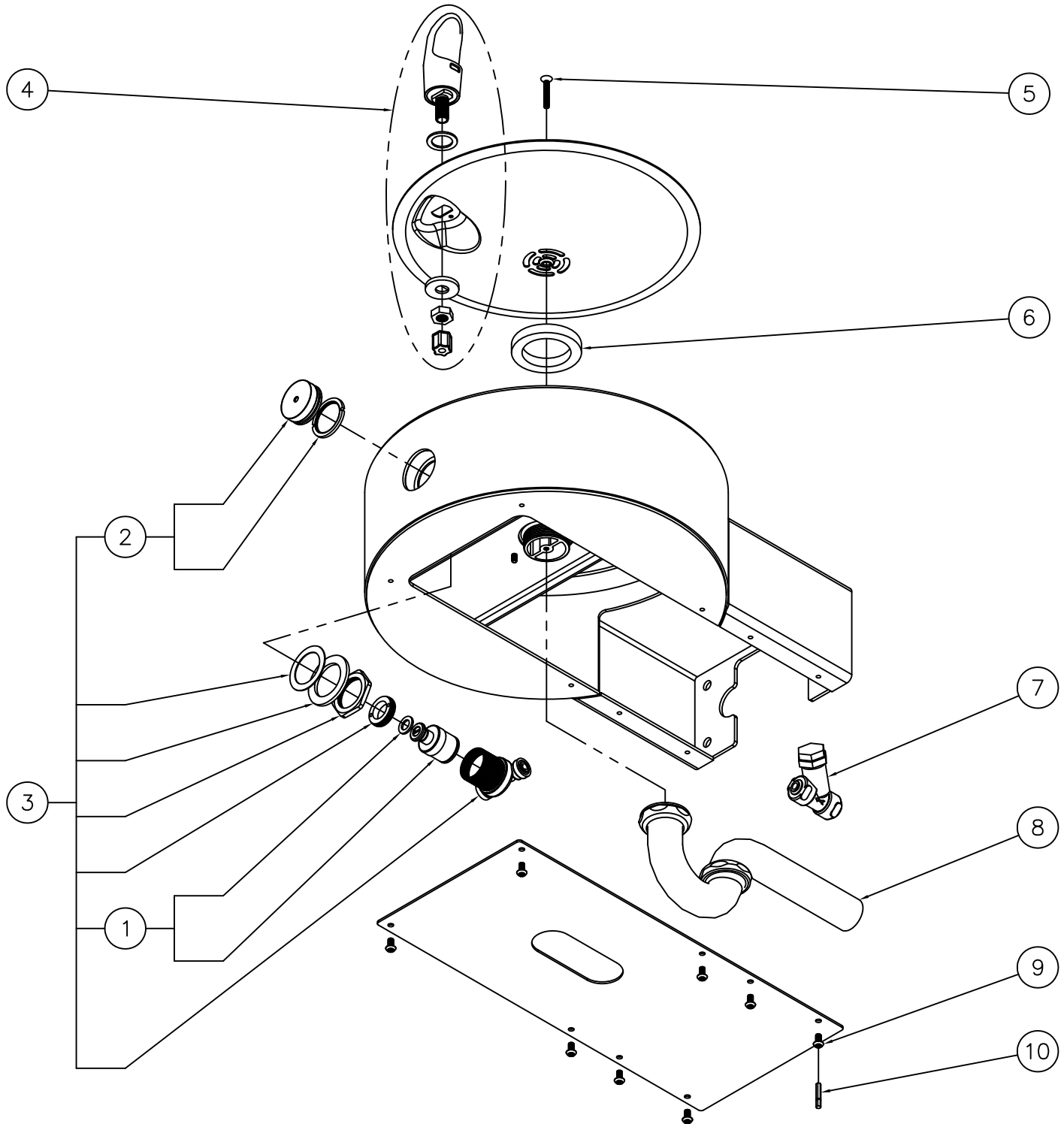

1	7000-050-001	VALVE CARTRIDGE	6	7000-006-000	FLAT DRAIN ADAPTER GASKET
2	7000-068-001	RETAINING RING AND BUTTON ASSEMBLY	7	7000-021-001	"Y" STRAINER
3	7000-065-001	RECESSED PUSHBUTTON VALVE ASSEMBLY	8	7000-015-000	1-1/4" OUTER DIAMETER P-TRAP
4	7000-012-001	STAINLESS STEEL BUBBLER	9	0112-002-000	CENTER REJECT ALLEN BUTTON HEAD SCREW
5	0152-010-000	CENTER REJECT ALLEN FLAT HEAD SCREW	10	0296-025-199	CENTER REJECT HEX DRIVER BIT
ITEM	PART NUMBER	DESCRIPTION	ITEM	PART NUMBER	DESCRIPTION



MURDOCK-SUPER SECUR
P.O. Box 3527 Industry, CA 91744
15125 Proctor Ave Industry, CA 91746
Phone: (800) 591-9880
www.murdock-supersecur.com

TITLE		
ROUND OUTDOOR STEEL WALL MOUNTED DRINKING FOUNTAIN		
MANUFACTURE DATE	DATE ISSUED	DRAWING NUMBER
JANUARY 2006 TO PRESENT	10/31/05	
	DATE REVISED	
	04/19/16	9938-100-500



INSTALLATION INSTRUCTIONS

STANDARD PUSH PAD / PUSH BUTTON DRINKING FOUNTAIN

CONDITION:

SOLUTION:

NO WATER FLOW:

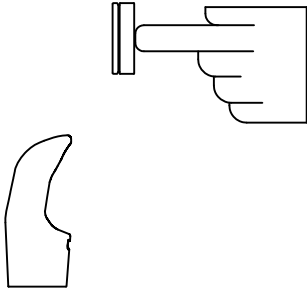

- 1.1 Check water main supply – open.
- 1.2 Inspect stop (by others) – open & no debris.
- 1.3 Inspect in–line strainer for debris – clean.
- 1.4 Replace valve cartridge.

WATER DRIPS / WILL NOT SHUT OFF:



- 2.1 For push pad activated drinking fountains only: Open fixture and move valve bracket assembly further back from push pad.
- 2.2 Replace valve cartridge.

REDUCED WATER FLOW:

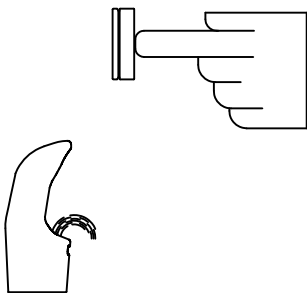

- 3.1 Adjust the valve flow rate. See appropriate fixture installation instructions.
- 3.2 Check water main supply for 20 psig minimum flow pressure.
- 3.3 Inspect stop (by others) – open & no debris.
- 3.4 Inspect in–line strainer for debris – clean.
- 3.5 Inspect bubbler for debris – clean.
- 3.6 Inspect all tubing for twists or kinks.
- 3.7 Replace valve cartridge.

 MURDOCK-SUPER SECUR P.O. Box 3527 Industry, CA 91744 15125 Proctor Ave Industry, CA 91746 Phone: (800) 591-9880 www.murdock-supersecur.com	TITLE DRINKING FOUNTAIN VALVE MAINTENANCE INSTRUCTIONS		
	MANUFACTURE DATE JANUARY 2006 TO PRESENT	DATE ISSUED 09/28/05 DATE REVISED 03/02/16	DRAWING NUMBER 9940-200-001